

GRADALL®

XL 4100 V

HYDRAULIC EXCAVATOR



SPECIFICATIONS

Undercarriage

6 x 4 or 6 x 6
Wheelbase: 171" (4.34m)
Width 102" (2.6m)

Frame:

48" (1.2m) wide, welded plate design
65 ksi material

Gross vehicle axle weight rating:

6 x 4 66,000 lb (29,937 kg)
6 x 6 69,000 lb (31,928 kg)

Front axles:

6 x 4: Meritor Model MFS-16-122A, 16,000 lb (7,257 kg) rating

6 x 6: Meritor Model MX19-145, 19,000 lb (8,618 kg) rating, 7.17 ratio

Rear axle:

Meritor Model RT-50-160, 50,000 lb (22,680 kg) rating, 7.17 ratio, single reduction with driver controlled differential lock in front/rear and interaxle differential with lock.

Suspension:

Front: 8 leaf spring with automatic lock-out cylinders

Rear: Hendrickson Equalizer Beam, 8" oscillation

Brakes:

6 x 4 Front: Meritor "Q" Plus Series Cam-Master Size: 16.5" x 5" (419 mm x 152 mm) Automatic Slack Adjusters

6 x 6 Front: Meritor "Q" Series Cam-Master Size: 16.5" x 6" (419 mm x 127 mm) Automatic Slack Adjusters

Rear: Meritor "P" Series Cam-Master Size: 16.5" x 7" (419 mm x 178 mm) Automatic Slack Adjusters

Spring brake system incorporates emergency and parking brakes on the rear axle. Heated air dryer.

Wheels:

Hub piloted disc 10-stud, 11.25" (286 mm) bolt circle.

Tires:

6 x 4 front: 385/65R22.5 LR (J) on/off highway tread

6 x 6 front: 425/65R22.5 LR (L) on/off highway traction tread

6 x 4 and 6 x 6 rear: 11R24.5 LR (H) on/off highway traction tread

Steering:

Ross, integral hydraulic power steering. Gear type power steering pump. 4-quart power steering reservoir with filter and 10 Micron pre-filter.

Standard chassis equipment:

Halogen headlights, tail lights, back-up lights and alarm, stoplights, identification lights front and rear, directional lights, 4-way hazard lights, and instrument panel lights. Windshield wiper/washer, West Coast style mirror system with plane and convex mirrors, front and rear tow hooks, desiccant type air dryer with automatic purge valve and thermostatically controlled heater.

Hydraulic System

PUMPS

One load-sensing axial piston pump; 0-77 GPM (0-291 L/min) total.

One gear pump (pilot & cooling) 11gpm (41 L/min.)

SYSTEM SPECIFICATIONS

Four double acting cylinders

- 1 Boom Cylinder: 3.5" (89mm) bore x 2.56" (65mm) rod x 150" (3.81m) stroke
- 2 Hoist Cylinders: 4.25" (108mm) bore x 3.15" (80mm) rod x 31" (787mm) stroke
- 1 Tool Cylinder: 5.0" (127mm) bore x 3.0" (76mm) rod x 25.9" (658mm) stroke

Three hydraulic motors

Swing, 64 Hp (48kW); tilt, 21 Hp (16kW); remote drive, 110 Hp (82kW) total.

Operating pressures

Hoist.....	4,800 psi (331 Bar)
Tilt.....	2,500 psi (172 Bar)
Swing.....	4,200 psi (290 Bar)
Tool.....	4,800 psi (331 Bar)
Telescope.....	4,800 psi (331 Bar)
Remote Propel.....	4,800 psi (331 Bar)
Pilot system.....	500 psi (35 Bar)

Oil capacity

Reservoir 50 gallons (189 L), system 70 gallons (265 L). Pressurized reservoir with visual oil level gauge.

Filtration system

5 micron return filter with magnet. 10 micron pilot filter.

Fin and tube-type oil cooler with thermostatically controlled cooling fan.

Pressure-compensated, load-sensing valves with circuit reliefs in all circuits.

Chassis Cab

One-person cab, left-hand mount, isolated from frame on rubber mounts. Acoustical lining. Sun visor. Gauges for oil pressure, coolant temperature, air tank pressures, fuel level, DEF level, voltmeter, speedometer with odometer, tachometer with hour meter. Engine and transmission monitor lights. Engine shutdown controlled by engine electronics. Indicator lights and controls for front axle engagement (6 x 6 only) and rear axle differential lock. Park brake control. Tinted safety glass. Sliding side windows. Fresh air heater and defroster. Dome light. Air suspension seat with seat belt. Vent in door.

Upperstructure Cab

All-weather cab isolated from frame on rubber mounts. Tinted safety glass windows, skylight, acoustical lining, four-way adjustable operator's seat, dome light, filtered air heater and defroster, AM/FM radio, air conditioning, work light package.

The heat source is provided by a fast response, closed circuit hydraulic heater with 20,000 BTU/Hr. capacity.

Front window slides to overhead storage. Mirrors on right and left sides of the machine. Windshield wiper and washer.

Hydraulic Remote Control

Upperstructure powered by chassis hydraulics through hydraulic motor and transfer case. Travel and steering pedals in upperstructure cab. Digging brakes and front axle lockout cylinders set automatically with travel pedal in neutral. Parking brake controlled by toggle. Electrically operated alarm mounted on undercarriage signals remote control movement in either direction, reverse movement when driven from undercarriage cab.

Engine

Volvo TAD871VE Tier 4f 7.7L diesel with selective catalytic reduction and cooled EGR technology. 4 cycle, inline 6 cylinder, liquid cooled. Turbo charge air after-cooled. Off-road certified, electronically controlled, grid heater. Vertical canister style lube filter attached to engine. Vertical canister style main fuel filter attached to engine. Volvo remote mount vertical style fuel/water separator with water in fuel indicator, alarm and manual feed pump.

Gross Rating: 248 HP @ 2200 RPM. 848 FT LB Torque @ 1200-1400 RPM.

Net Rating: 228 HP @ 2200 RPM.

Air Filter: 2-stage Donaldson PSD PowerCore with high efficiency pre-cleaner, vacuator valve and remote service indicator.

Electrical System: 24 volt, 110 amp alternator with integral voltage regulator. 2 SAE #C31-S 1000 CCA batteries.

Chassis Cooling Package: Consists of three aluminum bar-plate type coolers stacked vertically: an air-air charge air cooler, radiator and a transmission cooler. All three coolers are backed by a molded fan shroud, engine mounted fan ring and 26.8" nine-blade fan driven by a Volvo electronically controlled variable speed fan drive.

Fuel Tank Capacity: 100 gal (378 L)

Urea Tank Capacity: 11.9 gal (45 L)

Transmission: Allison 3500 RDS 6-speed automatic.

Gear Speeds:

Gear	1	2	3	4	5	6
MPH	6.3	16.2	24.1	37.4	50.6	59.9
Km/hr	(10.1)	(26.1)	(38.8)	(60.2)	(81.4)	(96.4)

Gear	REV
MPH	6.6
Km/hr	(10.6)

Drivelines: Spicer 1710 Series with "Half Round" yokes.

Transfer Case: (6 x 4) Cushman Model 479-1, 1:1 Ratio, Pneumatic engage for Remote Propel.

(6 x 6) Cushman Model 479A-1, 1:1 Ratio, Pneumatic engage for Remote Propel and Front Drive.

Swing

Internal swing gear. Priority swing circuit with axial piston motor. Planetary transmission.

Swing speed: 8 rpm.

Swing brake: Automatic spring-set/hydraulic release wet disc parking brake. Dynamic braking is provided by the hydraulic system.

Upperstructure Controls

Two electronic joysticks (hoist and bucket, telescope and swing), one rocker switch (tilt) control. Joysticks are mounted on arm pods that are adjustable for individual operator comfort and convenience. Quick change joystick pattern switch located on instrument panel.

Two foot pedals for remote control of undercarriage steering, travel and digging brakes.

Joysticks and pedals are self-centering; when controls are released, power for movement disengages and swing and travel brakes set automatically.

Engine Controls

Key ignition switch with neutral start and indicator lights for low air, engine status, park brake, travel status, hydraulic fluid temperature and level.

Automatic engine shutdown occurs with low oil pressure, derate/shutdown for oil temperature, coolant temperature, coolant level, ERD temperature, charge air temperature, charge air pressure and derate for SCR temperature.

GRADALL Model XL 4100 V Lift Capacity Over Side or Rear - LB. (KG.)

LOAD POINT HEIGHT		LOAD RADIUS										
		10' 0" (3.0 m)		15' 0" (4.6 m)		20' 0" (6.1 m)		25' 0" (7.6 m)		Maximum radius		
		Over End	Over Side	Over End	Over Side	Over End	Over Side	Over End	Over Side		Over End	Over Side
ABOVE GROUND LEVEL	20' 0" (6.1 m)									23' 5" (7.1m)	4795 (2175)	4795 (2175)
	15' 0" (4.6 m)			9935 (4505)	9935 (4505)	6915 (3135)	6915 (3135)	5030 (2280)	5030 (2280)	25' 10" (7.9m)	4785 (2170)	4785 (2170)
	10' 0" (3.0 m)			11710 (5310)	11400 (5170)	7775 (3525)	7280 (3300)	5520 (2505)	5055 (2295)	27' 0" (8.2m)	4860 (2205)	4420 (2005)
	BOOM LEVEL 8' 8" (2.7 m)			12000 (5445)	11310 (5130)	7920 (3590)	7235 (3280)	5605 (2540)	5030 (2280)	27' 2" (8.3m)	4885 (2215)	4355 (1975)
	5' 0" (1.5 m)			12130 (5500)	11005 (4990)	8065 (3660)	7085 (3215)	5725 (2595)	4940 (2240)	27' 2" (8.3m)	4980 (2260)	4275 (1940)
AT GROUND LEVEL				10750 (4875)	10585 (4800)	7640 (3465)	6865 (3115)	5575 (2530)	4810 (2180)	26' 5" (8m)	5135 (2330)	4390 (1990)
BELOW GROUND LEVEL	5' 0" (1.5 m)	9650 (4375)	9650 (4375)	8590 (3895)	8590 (3895)	6700 (3040)	6670 (3025)			24' 5" (7.5m)	5285 (2395)	4860 (2205)
	10' 0" (3.0 m)	6325 (2870)	6325 (2870)	6565 (2980)	6565 (2980)	5595 (2540)	5595 (2540)			21' 1" (6.4m)	5360 (2430)	5360 (2430)
	15' 0" (4.6 m)	4175 (1895)	4175 (1895)	4940 (2240)	4940 (2240)					15' 2" (4.6m)	4940 (2240)	4940 (2240)

Shaded areas are stability rated based on machine with 0 lb. bucket.

The rated lift capacity is based on the machine being equipped with 8,850 lb. (4014 kg) counterweight, standard boom and no bucket.

The load point is located on the bucket pivot point, including load listed for maximum radius.

Do not attempt to lift or hold any load greater than these rated values at specified load radii and heights. The weight of slings and any auxiliary devices must be deducted from the rated load to determine the net load that may be lifted.

ATTENTION: All rated loads are based on the machine being stationary and level on a firm supporting surface. For safe working loads, the user must make allowance for his particular job conditions such as soft or uneven ground, out of level conditions, side loads, hazardous conditions, experience of personnel, etc. The operator and other personnel must be fully trained and understand the Operator's Manual and Safety Manuals furnished by the manufacturer before operating this machine. Rules for safe operation of equipment must be adhered to at all times.

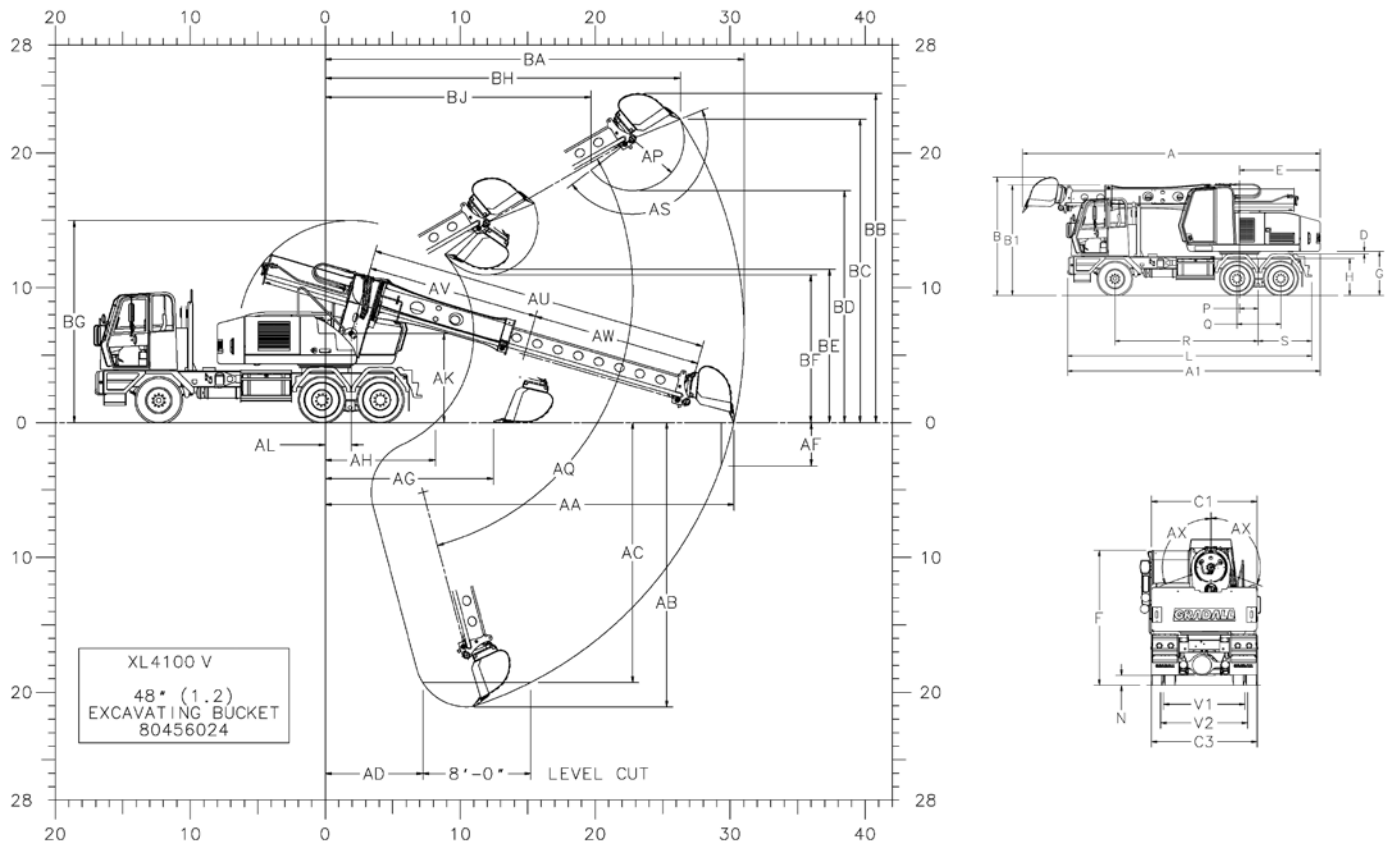

NOMENCLATURE AND DIMENSIONS FOR HYDRAULIC EXCAVATORS-SAE J1193 NOV84

	6 x 4	6 x 6		6 x 4	6 x 6	
A	29' 6" (9.0m)	29' 6" (9.0m)	Overall length (boom in rack) w/ bucket	AL	23" (584mm)	23" (584mm) Boom pivot to axis of rotation
A1	25' 1" (7.6m)	25' 1" (7.6m)	Overall length (boom in rack) w/o bucket	AP	46" (1.2m)	46" (1.2m) Bucket tooth radius
B	11' 9" (3.6m)	12' 0" (3.7m)	Overall height (boom in rack) w/ bucket	AQ	30° Up & 75° Dn	30° Up & 75° Dn Boom pivot angle
B1	10' 11" (3.3m)	11' 3" (3.4m)	Overall height (boom in rack) w/o bucket	AS	165°	165° Bucket pivot angle
C1	8' 6" (2.6m)	8' 6" (2.6m)	Width of upperstructure	AU	25' 3" (7.7m)	25' 3" (7.7m) Maximum telescoping boom length (boom pivot to bucket pivot)
C3	8' 6" (2.6m)	8' 6" (2.6m)	Width of undercarriage	AV	12' 9" (3.9m)	12' 9" (3.9m) Minimum telescoping boom length (boom pivot to bucket pivot)
D	3" (76mm)	3" (76mm)	Minimum clearance, upperstructure to undercarriage	AW	12' 6" (3.8m)	12' 6" (3.8m) Telescoping boom travel
E	8' 0" (2.4m)	8' 0" (2.4m)	Swing clearance, rear of upperstructure	AX	110°	110° Bucket tilt angle (both sides of center)
F	10' 10" (3.3m)	11' 1" (3.4m)	Top of cab to ground line	BA	31' 0" (9.5m)	31' 0" (9.5m) Maximum radius of working equipment
G	52" (1.3m)	56" (1.4m)	Clearance, upperstructure to ground line	BB	24' 5" (7.4m)	24' 8" (7.5m) Maximum height of working equipment
H	44" (1.1m)	48" (1.2m)	Top of wheel mounted under carriage frame to ground line	BC	22' 6" (6.9m)	22' 10" (6.9m) Maximum bucket tooth height
L	24' 2" (7.4m)	24' 2" (7.4m)	Overall length of undercarriage	BD	17' 2" (5.2m)	17' 6" (5.3m) Minimum clearance of bucket teeth, with bucket pivot at maximum height
N	10" (254mm)	10" (254mm)	Ground clearance (per SAE J1234)	BE	11' 4" (3.5m)	11' 8" (3.6m) Minimum clearance of fully curled bucket at maximum boom height
P	22" (564mm)	22" (564mm)	Center of rear tandem to axis of rotation	BF	10' 11" (3.3m)	11' 3" (3.4m) Minimum clearance of bucket teeth at maximum boom height
Q	52" (1.3m)	52" (1.3m)	Distance between centers of tandem axles	BG	15' 0" (4.6m)	15' 3" (4.7m) Maximum height of working equipment with bucket below ground line
R	14' 2" (4.3m)	14' 2" (4.3m)	Wheelbase	BH	26' 4" (8.0m)	26' 4" (8.0m) Radius of bucket teeth at maximum height
S	5' 4" (1.6m)	5' 4" (1.6m)	Center of rear axle to rear of frame (step)	BJ	19' 8" (6.0m)	19' 8" (6.0m) Minimum radius of bucket teeth at maximum bucket pivot height
V1	6' 7" (2.0m)	6' 7" (2.0m)	Tread, rear axles (285/75R24.5 tires)			
V2	7' 0" (2.1m)	7' 0" (2.1m)	Tread, front axle (385/65R22.5 tires)			
AA	30' 3" (9.2m)	30' 2" (9.2m)	Maximum radius at ground line (165° pivot)			
AB	20' 3" (6.2m)	19' 11" (6.1m)	Maximum digging depth			
AC	19' 3" (5.9m)	19' 0" (5.8m)	Maximum depth for 8' level cut			
AD	7' 3" (2.2m)	7' 3" (2.2m)	Minimum radius of 8' level cut at depth "AC"			
AF	3' 3" (1.0m)	3' 3" (1.0m)	Maximum depth of vertical wall which can be excavated			
AG	12' 5" (3.8m)	12' 4" (3.8m)	Minimum level cut radius with bucket flat on ground line			
AH	8' 2" (2.5m)	7' 10" (2.4m)	Minimum radius at ground line			
AK	6' 7" (2m)	6' 11" (2.1m)	Boom pivot to ground line			

Rated bucket tangential force with 36" (914mm) bucket: 24,900 lb (111kN)

Rated telescoping boom crowd force: 21,940 lb (97.6 kN)

Weight: Approximate working weight, fuel tank half full
 6 x 4: 49,684 lb (22,539 kg)
 6 x 6: 50,925 lb (23,099 kg)

Specifications subject to change without notice.

Optional Equipment

Vandalism protection kit including window covers.

Strobe light.

Block heater.

Tilt steering column.

Auxiliary Hydraulics - Additional hosing and piping for hydraulic powered attachments. [Maximum pressure 4800 psi (33,095 kPa) Maximum flow 30 GPM (114 L/min)]

Attachments

Quick change and reversible buckets fabricated of steel plate, with high strength, low alloy cutting edges and wear strips. Standard attachments available for wide range of applications. Capacities shown are in heaped cu. yd.

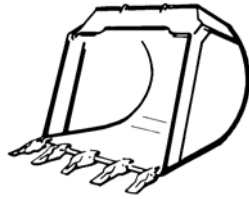

8045-6020	24" (610mm)	Excavating bucket	Cu. yd.	m3
8045-6021	30" (762mm)	Excavating bucket	3/8	0.31
8045-6022	36" (914mm)	Excavating bucket	1/2	0.41
8045-6023	42" (107m)	Excavating bucket	5/8	0.54
8045-6023	42" (107m)	Excavating bucket	3/4	0.64
8045-6024	48" (122m)	Excavating bucket	1	0.76



8065-6013	72" (1.83m)	Dredging bucket	Cu. yd.	m3
			1 1/8	0.87

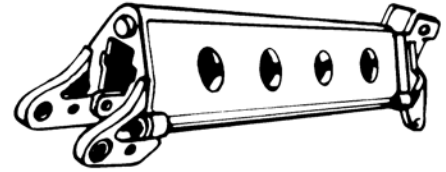

8065-5028	4' (1.2 m)	Boom extension
8065-5029	6' (1.8 m)	Boom extension
8065-5030	8' (2.4 m)	Boom extension



8065-6104	15" (381mm)	Trenching bucket	Cu. yd.	m3
8065-6012	21" (533mm)	Trenching bucket	1/5	0.15
			1/4	0.19

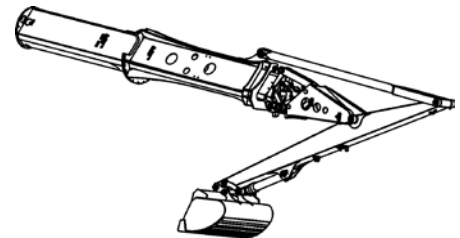

8075-5045 Telestick attachment

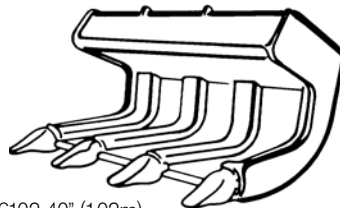

8065-6102 40" (1.02m) Pavement removal bucket

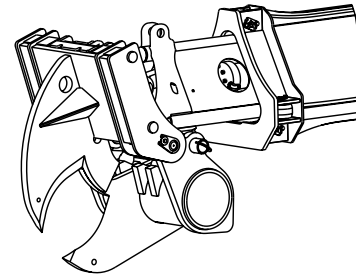

8045-5052 Tree limb shear attachment

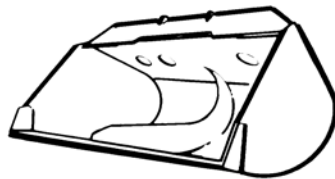

8065-6007	60" (1.52m)	Ditching bucket	Cu. yd.	m3
8065-6006	66" (1.68m)	Ditching bucket	7/8	0.73
8065-6002	72" (1.83m)	Ditching bucket	1	0.76
			1 1/8	0.87

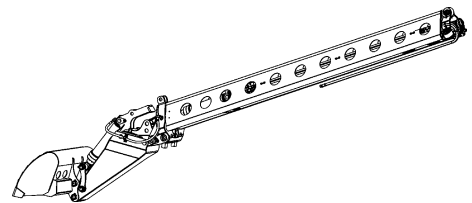

8075-5034 7' (2.1 m) Adjustable angle extension

It is Gradall Policy to continually improve its products. Therefore designs, materials and specifications are subject to change without notice and without incurring any liability on units already sold. Units shown may have optional equipment.

GRADALL®

406 Mill Ave. SW, New Philadelphia, Ohio 44663
Phone: 330-339-2211 Fax: 330-339-8468
www.Gradall.com

Certified ISO 9001



Form No. 11637 1/17
Printed in USA

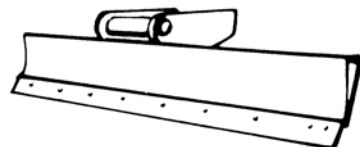

8065-6024 8' (2.4 m) Grading blade

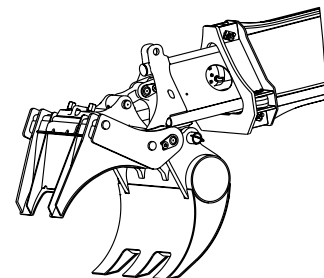

8075-5023 Fixed thumb grapple